

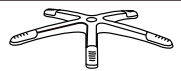













# ASSEMBLY INSTRUCTIONS/INSTRUCTIONS DE MONTAGE/ INSTRUCCIONES DE MONTAJE/ MONTAGEANLEITUNG/ MONTAGE-INSTRUCTIES

|   |   |   |
|---|---|---|
| A |    | 5 |
| B |    | 1 |
| C |    | 1 |
| D |    | 1 |
| E |    | 4 |
| F |    | 4 |
| G |    | 2 |
| H |    | 4 |
| I |    | 4 |
| J |    | 2 |
| K |    | 1 |
| L |  | 1 |
| M |  | 1 |
| N |  | 1 |
| O |  | 1 |
| P |  | 1 |



|   |   |
|---|---|
|    | <b>WARNING</b><br>PINCH POINT<br>MOVING PART CAN<br>CRUSH OR CUT.<br>KEEP CLEAR   |
|    | <b>ATTENTION</b><br>POINT DE<br>PINCEMENTUNE PIÈCE<br>MOBILE PEUT ÉCRASER<br>OU COUPER.<br>GARDER CLAIR                   |
|    | <b>WARNUNG</b><br>PINCH POINT<br>BEWEGLICHES TEIL<br>KANN ZERquetschen<br>ODER SCHNEIDEN.<br>FREI HALTEN                  |
|   | <b>WAARSCHUWING</b><br>KNELPUNT HET<br>BEWEGENDE DEEL<br>KAN VERPLETLEN<br>OF SNIJDEN.<br>HOUD DUIDELIJK                  |
|  | <b>ADVERTENCIA</b><br>PUNTO DE PELLIZCO<br>LA PIEZA EN<br>MOVIMIENTO PUEDE<br>APLASTARSE O<br>CORTARSE.<br>MANTENER CLARO |
|  | <b>AVVERTIMENTO</b><br>PUNTO DI PRESA<br>LA PARTE IN<br>MOVIMENTO PU CR<br>SPACCARE O TAGLIARE.<br>LASCIARE LIBERO        |

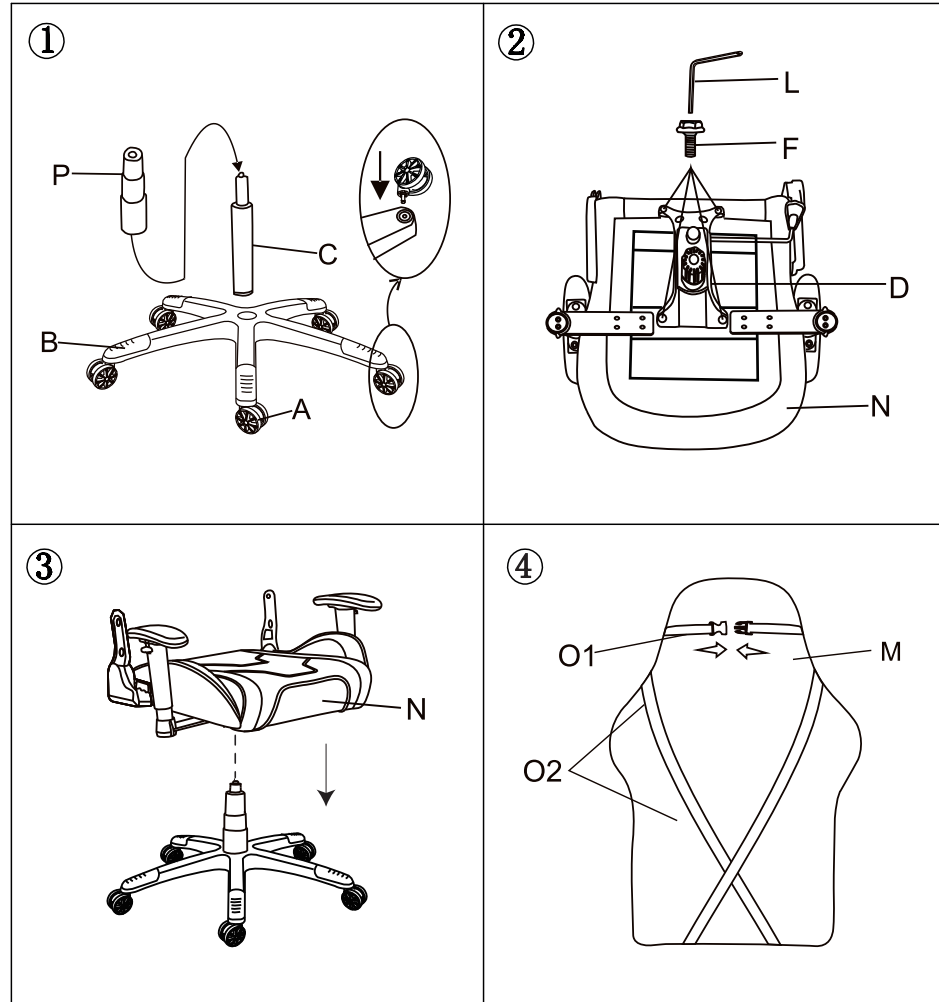

IF THERE ARE ANY PARTS MISSING OR YOU NEED FURTHER ASSISTANCE, PLEASE EMAIL: [SERVICE@XROCKERNATION.CO.UK](mailto:SERVICE@XROCKERNATION.CO.UK)  
 SI FALTAN PIEZAS O NECESITA MÁS AYUDA, POR FAVOR EMAIL: [SERVICE@XROCKERNATION.CO.UK](mailto:SERVICE@XROCKERNATION.CO.UK)  
 S'IL Y A DES PIÈCES MANQUANTES OU SI VOUS AVEZ BESOIN D'AIDE, VEUILLEZ EMAIL: [SERVICE@XROCKERNATION.CO.UK](mailto:SERVICE@XROCKERNATION.CO.UK)  
 WENN TEILE FEHLEN ODER SIE WEITERE HILFE BENÖTIGEN, EMAIL: [SERVICE@XROCKERNATION.CO.UK](mailto:SERVICE@XROCKERNATION.CO.UK)  
 ALS ER ONDERDELEN ONTBREKEN OF ALS U MEER HULP NODIG HEBT, U EMAIL: [SERVICE@XROCKERNATION.CO.UK](mailto:SERVICE@XROCKERNATION.CO.UK)

# ASSEMBLY INSTRUCTIONS/INSTRUCTIONS DE MONTAGE/ INSTRUCCIONES DE MONTAJE/ MONTAGEANLEITUNG/ MONTAGE-INSTRUCTIES

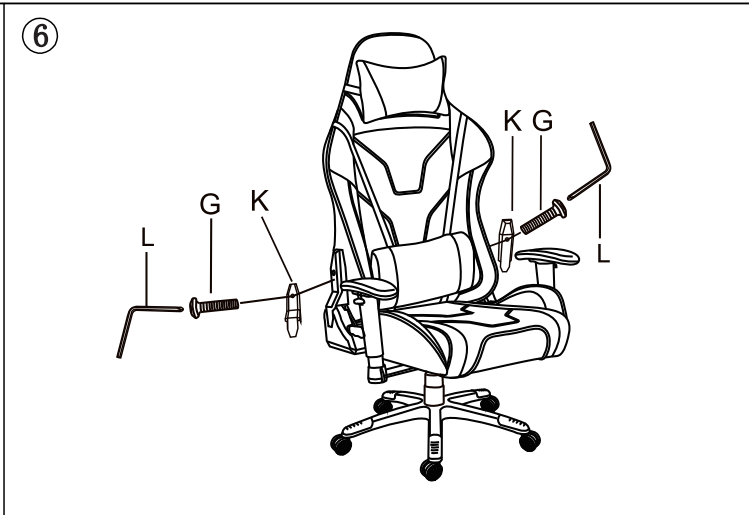
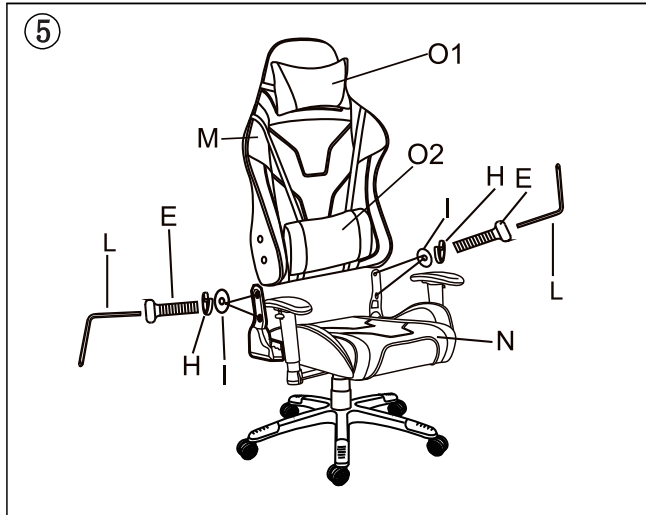

## ⚠ Warning!

Chair arms are for gaming support only. To avoid damage or injury, do not sit on the arms. Do not use arms to EXIT from the chair or to MOVE or LIFT the chair.

## ⚠ Avertissement !

Les accoudoirs du fauteuil sont conçus uniquement pour être utilisés comme éléments de soutien lorsque vous jouez. Pour éviter d'endommager le fauteuil ou de vous blesser, ne vous asseyez pas sur les accoudoirs. N'utilisez pas les accoudoirs pour vous LEVER du fauteuil ou pour DÉPLACER ou SOULER le fauteuil.

## ⚠ Avvertimento !

Le braccia della sedia sono solo per il supporto di gioco. Evitare danni o lesioni, non sedersi sulle braccia. Non usare le braccia per USCIRE dalla sedia o spostare o sollevare la sedia.

## ⚠ ¡Advertencia!

Los reposabrazos de la silla deben utilizarse únicamente como apoyo durante el juego. Para evitar daños o lesiones, no se sienten sobre los reposabrazos. No utilice los reposabrazos para LEVANTARSE de la silla ni para MOVER o LEVANTAR la silla.

## ⚠ Warnung !

Die Armlehnen sind nur zur Unterstützung beim Spielen bestimmt. nicht, um aus dem Sessel AUFZUSTEHEN, um den Sessel zu BEWEGEN oder HOCHZUHEBEN.

## ⚠ Waarschuwing!

Stoelarmen zijn alleen bedoeld voor gaming-ondersteuning. Ga niet op de armen zitten om schade of letsel te voorkomen. Gebruik de armen niet om uit de stoel OP TE STAAN of om de stoel te VERPLAATSEN of TE TILLEN.

**XRocker**

IF THERE ARE ANY PARTS MISSING OR YOU NEED FURTHER ASSISTANCE, PLEASE EMAIL: [SERVICE@XROCKERNATION.CO.UK](mailto:SERVICE@XROCKERNATION.CO.UK)  
 SI FALTAN PIEZAS O NECESITA MÁS AYUDA, POR FAVOR EMAIL: [SERVICE@XROCKERNATION.CO.UK](mailto:SERVICE@XROCKERNATION.CO.UK)  
 S'IL Y A DES PIÈCES MANQUANTES OU SI VOUS AVEZ BESOIN D'AIDE, VEUILLEZ EMAIL: [SERVICE@XROCKERNATION.CO.UK](mailto:SERVICE@XROCKERNATION.CO.UK)  
 WENN TEILE FEHLEN ODER SIE WEITERE HILFE BENÖTIGEN, EMAIL: [SERVICE@XROCKERNATION.CO.UK](mailto:SERVICE@XROCKERNATION.CO.UK)  
 ALS ER ONDERDELEN ONTBREKEN OF ALS U MEER HULP NODIG HEBT, U EMAIL: [SERVICE@XROCKERNATION.CO.UK](mailto:SERVICE@XROCKERNATION.CO.UK)