

Assembly Instructions/Instructions de montage/ Instrucciones de montaje/ Montageanleitung/Montage-instructies/Istruzioni di montaggio

XRocker









⚠ Warning! Chair arms are for gaming support only. To avoid damage or injury, do not sit on the arms. Do not use arms to EXIT from the chair or to MOVE or LIFT the chair.

⚠ Avertissement ! Les accoudoirs du fauteuil sont conçus uniquement pour être utilisés comme éléments de soutien lorsque vous jouez. Pour éviter d'endommager le fauteuil ou de vous blesser, ne vous assoyez pas sur les accoudoirs. N'utilisez pas les accoudoirs pour vous LEVER du fauteuil ou pour DÉPLACER ou SOULEVE le fauteuil.

⚠ ¡Advertencia! Los reposabrazos de la silla deben utilizarse únicamente como apoyo durante el juego. Para evitar daños o lesiones, no se sienten sobre los reposabrazos. No utilice los reposabrazos para LEVANTARSE de la silla ni para MOVER o LEVANTAR la silla.

⚠ Warnung ! Die Armlehnen sind nur zur Unterstützung beim Spielen bestimmt, nicht, um aus dem Sessel AUFZUSTEHEN, um den Sessel zu BEWEGEN oder HOCHZUHEBEN.

⚠ Waarschuwing! Stoelarmen zijn alleen bedoeld voor gaming-ondersteuning. Ga niet op de armen zitten om schade of letsel te voorkomen. Gebruik de armen niet om uit de stoel OP TE STAAN of om de stoel te VERPLAATSEN of TE TILLEN.

A		5
B		1
C		1
D		1
E		1
F	M6*20	4
G	Ø6*Ø18	4
H	M8*30	4
I	Ø8*Ø18	4
J	M8*40	4
K	M6	1
L		2
M		1
N		1
O		4

⚠ Avvertimento ! Le braccia della sedia sono solo per il supporto di gioco. Evitare danni o lesioni, non sedersi sulle braccia. Non usare le braccia per USCIRE dalla sedia o spostare o sollevare la sedia.

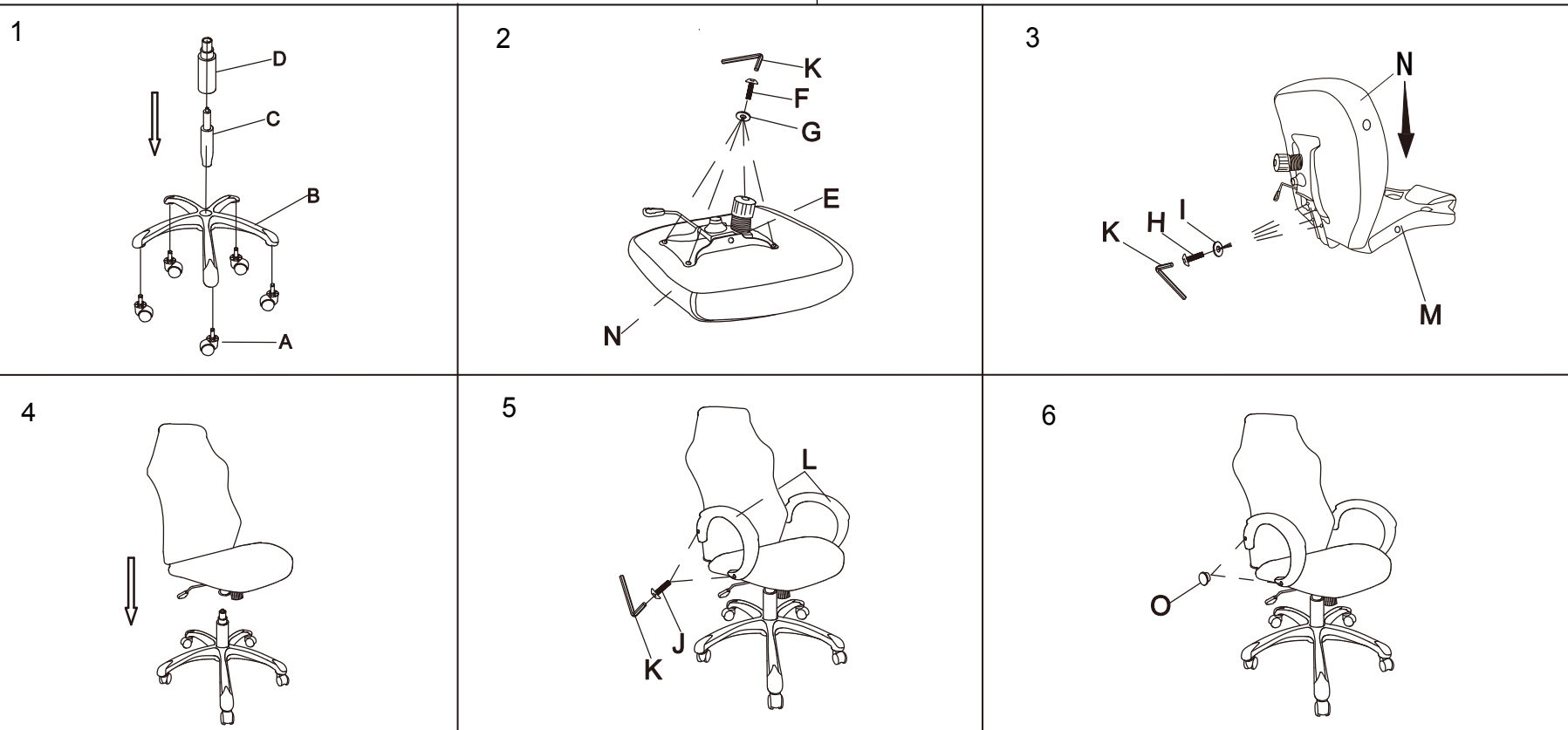

If there are any parts missing or you need further assistance, contact X Rocker at: www.xrockeruk.com/pages/support
 Si faltan piezas o necesita más ayuda, Póngase en contacto con X ROCKER en: www.xrockeruk.com/pages/support
 S'il y a des pièces manquantes ou si vous avez besoin d'aide, Contactez X ROCKER au: www.xrockeruk.com/pages/support
 Wenn Teile fehlen oder Sie weitere Hilfe benötigen, Wenden Sie sich an X ROCKER unter: www.xrockeruk.com/pages/support
 Als er onderdelen ontbreken of als u meer hulp nodig hebt, Neem contact op met X ROCKER op: www.xrockeruk.com/pages/support
 Se ci sono parti mancanti o avete bisogno di ulteriore assistenza, Contattare X ROCKER all'indirizzo: www.xrockeruk.com/pages/support